

**SAMSUNG**

**ENGLISH**

**FRIDGE/FREEZER**



# **Instruction Manual**

Before operating the appliance, please read this manual thoroughly and retain it for future refererce.

## Safety Precautions

EN

Before using your fridge/freezer, read the safety precautions below and the instructions in the rest of the manual. Keep the Instruction Manual in a handy place for future reference and remember to hand it over to the subsequent owner, if you ever sell the appliance.

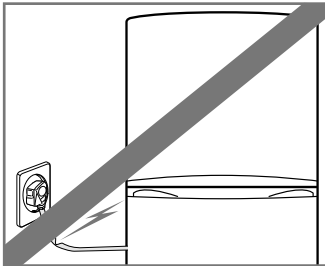

DO NOT use the fridge/freezer if it is faulty or damaged. Unplug it from the power supply and call your local service centre. If the power cord is damaged, have it replaced by the manufacturer, an approved service centre or a qualified electrician.

The appliance must be positioned so that the plug is accessible after installation

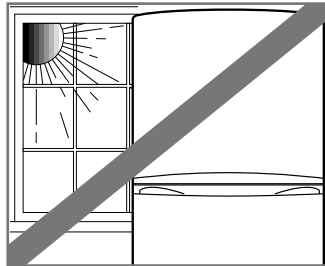

DO NOT expose the fridge/freezer to direct sunlight. DO NOT install it next to a source of heat (oven, radiator). If you must install the fridge/freezer near a source of heat, ensure that there is sufficient insulation between the two appliances.

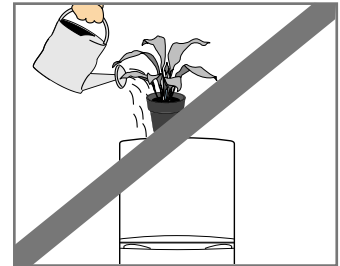

DO NOT allow water to splash or run on to the back of the fridge/freezer. Water impairs the insulation of the electrical parts and may cause an electric short circuit or risk of electric shock.

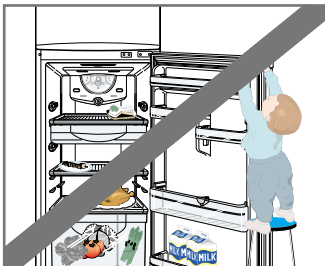

DO NOT allow children to:

- ◆ Play in or around the fridge/freezer
- ◆ Hang on the refrigerator door

Children may be injured and the appliance may be damaged.

The appliance is not intended for use by young children or infirm persons without supervision.

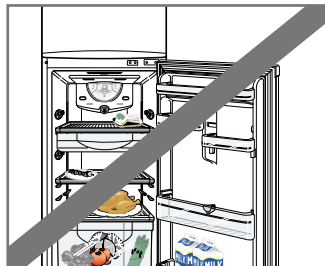

To maintain the efficiency of your fridge/freezer, DO NOT leave the doors open for any longer than necessary. Make sure that the doors are carefully pushed closed at all times.

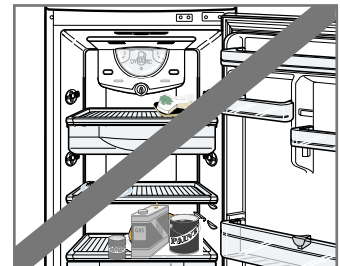

DO NOT store volatile chemicals, such as ether and benzene, in the fridge/freezer. Besides damaging the food, the fumes can build up and cause an explosion.

DO NOT use flammable sprays, such as lacquer or paint, near the fridge/freezer.

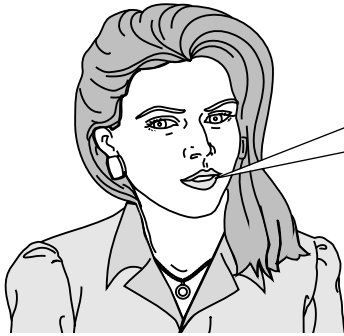

*Thank you for purchasing a  
SAMSUNG fridge/freezer.*

*Please take the time to read  
these instructions, as they will enable  
you to take full advantage of your  
new appliance.*

## Contents

◆ SAFETY PRECAUTIONS .....	2
◆ BECOMING FAMILIAR WITH YOUR NEW FRIDGE/FREEZER	
■ Main Features.....	4
■ Model Specifications.....	4
◆ INSTALLING YOUR NEW FRIDGE/FREEZER	
■ Choosing Where to Install Your Fridge/Freezer .....	5
■ Earthing the Fridge/Freezer.....	5
■ Preparing Your Fridge/Freezer for Use .....	6
■ Adjusting the Feet.....	6
■ Arranging the Accessories.....	7
◆ USING YOUR REFRIGERATOR	
■ Controlling the Refrigerator Temperature.....	8
■ Storing Food .....	8
■ Using the Chiller Compartment (OPTION) .....	9
■ Using the Vegetable Bin .....	9
◆ USING YOUR FREEZER	
■ Controlling the Freezer Temperature .....	10
■ Freezing Food .....	10
■ Making Ice Cubes.....	11
◆ LOOKING AFTER YOUR FRIDGE/FREEZER	
■ Cleaning the Fridge/Freezer.....	12
■ Changing the Light Bulb .....	13
■ Problems and Solutions.....	14
◆ VIEW OF YOUR FRIDGE/FREEZER .....	15

## Main Features

Your fridge/freezer is fitted with several useful features, to help you store food as efficiently and as hygienically as possible.

Feature	Description
Auto-defrost	When sufficient frost has accumulated in the fridge/freezer, the auto-defrost feature starts up automatically. The frost is thawed and the thaw water is collected in an evaporation tray, which allows it to evaporate. This operation is fully automatic and requires no intervention by you.
Bio-deodorizer (OPTION)	This integrated ventilation system helps remove odor from the refrigerator, by moving the air in such a way that smells cannot collect and contaminate the food. The bio-deodorizer is located at the top of fresh food compartment.
Chiller compartment (OPTION)	The chiller compartment freezes only the surface of the food to help: <ul style="list-style-type: none"> <li>◆ Preserve the taste of the food</li> <li>◆ Prolong the freshness</li> </ul>
Adjustable shelves and containers	The accessories inside your fridge/freezer can be placed in the positions that best suit your requirements and the food to be stored. The specially large compartments in the bottom of the door are very practical when chilling bottles of drinks for example.

## Model Specifications

Type: \_\_\_\_\_

Date of Purchase: \_\_\_\_\_

The instructions in this booklet apply to several models and types.  
The main differences between the models concern whether you have:

- ◆ A chiller compartment / A multi-purpose drawer
- ◆ Shelf : Crystal / Wire / Tempered glass
- ◆ Bio deodorizer
- ◆ Twist ice maker / Movable ice tray

### Important

These appliances are intended for household use only. If you wish to use them for industrial or commercial purposes, you must check that you comply with all applicable standards and regulations.

Model Number: \_\_\_\_\_

## Choosing Where to Install Your Fridge/Freezer

Various factors must be taken into account when choosing where to install your fridge/freezer.

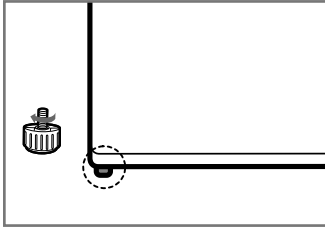

Install the fridge/freezer on a stable, flat surface. Adjust the feet if necessary, referring to page 6 for further details.

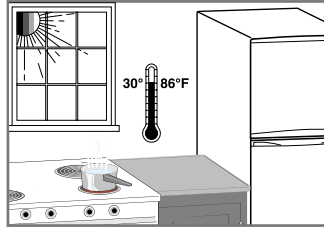

Avoid locations in direct sunlight or near to heaters, radiators, ovens or cookers.

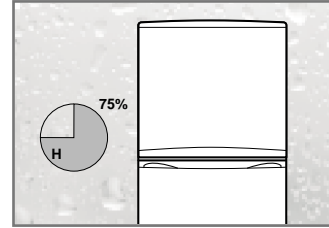

Avoid locations affected by draughts or dampness.

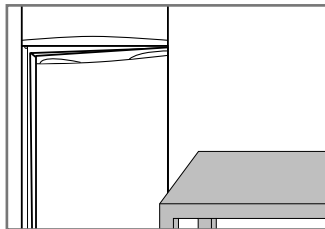

Make sure that you can open the doors freely and without hindrance.

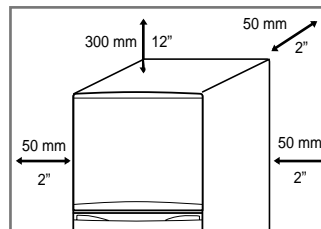

Allow the following clearances around the fridge/freezer:

- ◆ 50 mm (2 inches) on all sides
- ◆ 300 mm (12 inches) above the fridge/freezer

## Earthing the Fridge/Freezer

For the personal safety of you and your family, your fridge/freezer must be:

- ◆ Plugged into its own individual wall outlet with the correct voltage and frequency, as indicated inside the refrigerator door
- ◆ Properly earthed (do not ground the fridge/freezer with a telephone line, gas pipe, and so on)

To minimise the possibility of electric shocks from the appliance, the wall outlet must also be earthed; have it checked by a qualified electrician. If it is not earthed, it is your personal responsibility and obligation to have it replaced with a properly earthed outlet, or use a different power point.



If the power cord is damaged, avoid a hazard by replacing it through the manufacturer or its service agent or a similarly qualified person.

In case of power plug without ground terminal.

- ◆ Connect one side of the ground wire (yellow/green or green color) with the ground screw, another side of the ground terminal with steel or copper pipe such as water pipe tap.

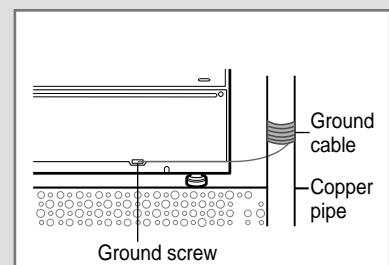
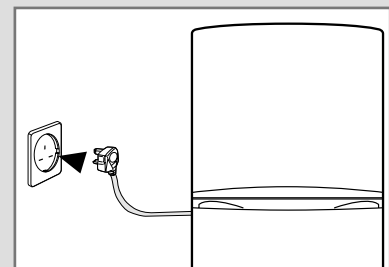

## Preparing Your Fridge/Freezer for Use

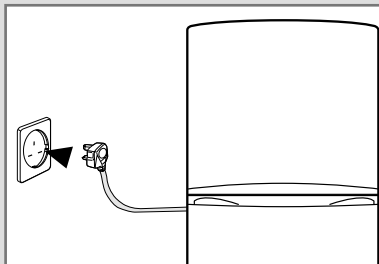
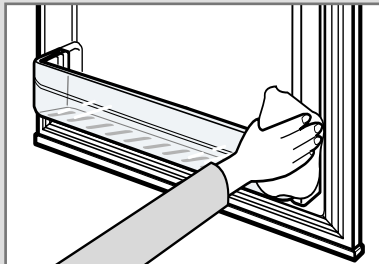

Once you have chosen the position of your fridge/freezer and checked that the wall outlet is correctly earthed, proceed as follows.

- 1 Make sure that the fridge/freezer is unplugged from the wall outlet.
- 2 Wipe the appliance clean inside and out with a soft cloth and warm, soapy water.
- 3 Allow the fridge/freezer to stabilize for at least one hour before plugging it in for the first time.
- 4 Plug the power cord into the appropriate earthed wall outlet.
- 5 Set the refrigerator and freezer temperatures, referring to pages 8 and 10, respectively for further instructions.
- 6 Wait for 2-3 hours for the freezer to reach the required temperature, before placing frozen food in the freezer.

## Adjusting the Feet

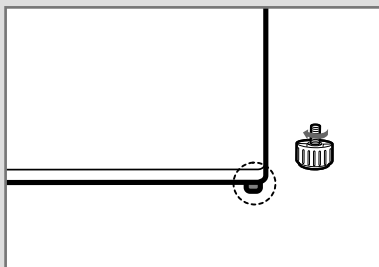
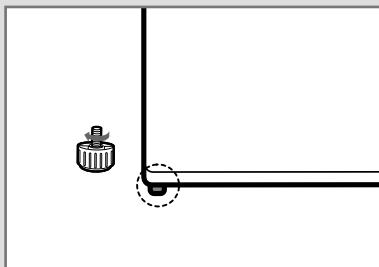

To compensate for an uneven floor surface, you can adjust the feet on the front of the fridge/freezer.

If the fridge/freezer leans to the...	Then turn the...
Left	Left foot anti-clockwise until the fridge/freezer is level.
Right	Right foot anti-clockwise until the fridge/freezer is level.

When you store a lot of food in the guards of the doors, it may be unstable.  
In that case, set the front leg parallel to the rear leg.

## Arranging the Accessories

The shelves and compartments inside the refrigerator can be rearranged for greater convenience.

To change the position of...	Then...
A crystal shelf / A tempered glass shelf	<ul style="list-style-type: none"> <li>◆ Pull the shelf towards you until it reaches the stop</li> <li>◆ Tilt the front of the shelf up and continue pulling the shelf towards you</li> <li>◆ Slide the shelf back into its new position</li> </ul>
A wire shelf	<ul style="list-style-type: none"> <li>◆ Tilt the front of the shelf up</li> <li>◆ Pull the shelf out towards you</li> <li>◆ Slide the shelf back into its new position</li> </ul>
An adjustable door pocket	<ul style="list-style-type: none"> <li>◆ Lift the compartment upwards to release the tabs</li> <li>◆ Remove the compartment from the door</li> <li>◆ Align the tabs in the new position</li> <li>◆ Push the compartment down into place</li> </ul>

### Arrangement Example for the Refrigerator

Accessory	Suggested Use
Top shelf	Desserts, such as yoghurts
Chiller compartment	Meats and fish
Bottom shelf	Ready-prepared meals
Vegetable bin	Fruit and vegetables
Egg Tray	Eggs
Adjustable door pocket	Cheese, butter
Bottle pocket	Milk, sodas, other drinks

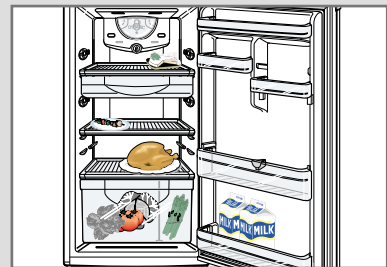
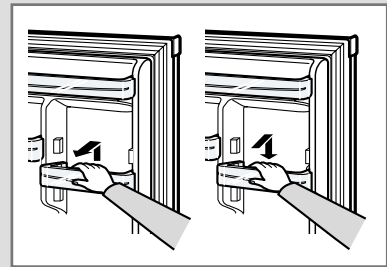
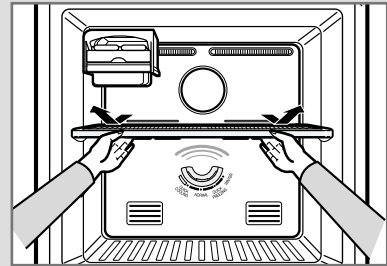
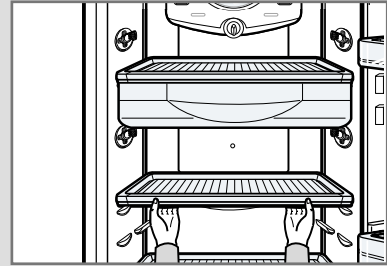

## Controlling the Refrigerator Temperature

EN

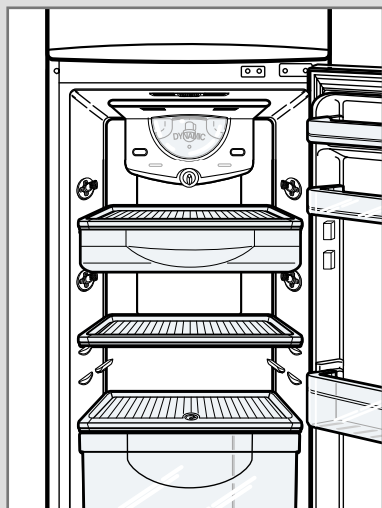

When setting the refrigerator temperature, you must take into account the following factors:

- ◆ The amount of food to be stored
- ◆ The temperature of the room in which the fridge/freezer is placed

To store...	Then set the temperature to...
A large amount of food (refrigerator full)	COLDER
An average amount of food	Between COLDER and COLD
A small amount of food (refrigerator relatively empty)	COLD

- Depending on the room temperature, you may need to turn the refrigerator up or down slightly. If it is very low set the refrigerator temperature to COLD.
- In case of being much foods in fresh food compartment, specially in summer, turn the freezer temperature dial to "QUICK COOLING" to direct more cold air into the fresh food compartment and the refrigerator temperature dial to "6-7". Setting at "QUICK FREEZING" fresh food compartment will not be cold enough. Put the freezer compartment in "WINTER" when the ambient temperature drops below 10°C, and turn the refrigerator dial to "4-5".

## Storing Food

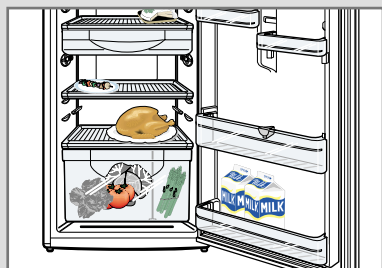

Follow the recommendations below when storing food in the refrigerator.

- 1 Put food in containers with lids or in plastic bags or cover it with plastic film to prevent:
  - ◆ The food from drying up
  - ◆ Smells from permeating other items of food
- 2 Allow hot food or drinks to cool before placing them in the refrigerator.
- 3 Leave sufficient room between the items and in front of the ventilation slots to enable the cool air to circulate freely.
- 4 Try and maintain easy access to the temperature dial in case you need to adjust the temperature.
- 5 If you have washed any fruit or vegetables, dry them before storing them in the vegetable bin.



## Using the Chiller Compartment

OPTION

The chiller compartment freezes only the surface of the food to help:

- ◆ Preserve the taste of the food
- ◆ Prolong the freshness

Use the chiller compartment to store cheese, meat, fish or any frozen food to be used quickly.

To...	Then...
Open the chiller compartment	Pull the chiller compartment towards you.  <u>Result:</u> ◆ The compartment is moved forward for easy access. ◆ The cover opens automatically.
Close the chiller compartment	Push the chiller compartment back as far as it will go. <u>Result:</u> The cover closes automatically.

➤ Make sure, however, that the cover is correctly closed before shutting the refrigerator door.

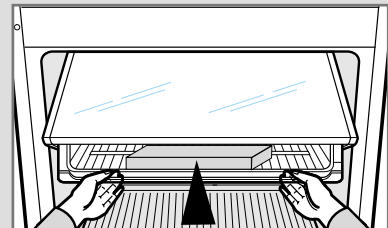
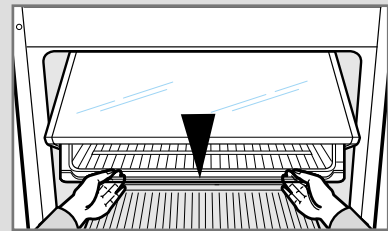

## Using the Multi-Purpose Drawer

The multi-purpose drawer can be used as both Chiller compartment and Vegetable bin by changing the location of drawer.

- ◆ Chiller compartment :  
When drawer is placed under the top shelf.
- ◆ Vegetable bin (humidity adjustable):  
When drawer is placed between the cover-vegetable and the vegetable bin (In this case, cover-vegetable must be placed one-level upward).

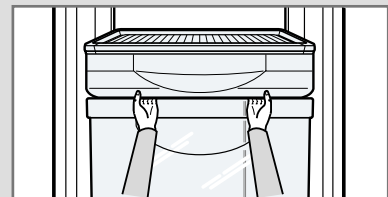
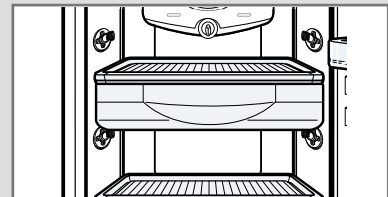

## Using the Vegetable Bin

The vegetable bin maintains the moisture and freshness of fruit and vegetables by:

- ◆ Protecting the items from direct draughts of cold air
- ◆ Maintaining sufficient humidity to prevent the fruit and vegetables from drying out
- ◆ The vegetable bin divider allows you separately to store the fruit and vegetables. (Option).



The vegetable bin is not suitable for tropical fruit (bananas, pineapple and so on), which is too fragile: the fruit is damaged and flavour is lost.

To...	Then...
Open the vegetable bin	Pull it towards you.
Close the vegetable bin	Push it back into place.

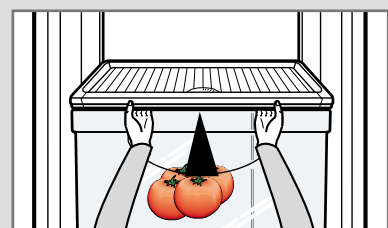
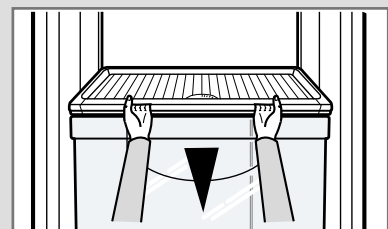

## Controlling the Freezer Temperature

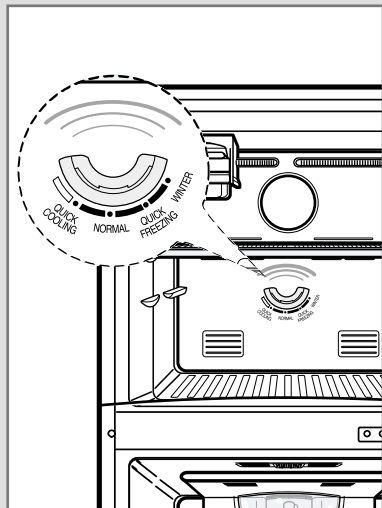

When setting the freezer temperature, you must take into account the following factors:

- ◆ The amount of food to be frozen
- ◆ The temperature of the room in which the fridge/freezer is placed

To...	Then set the temperature to...
◆ Store large quantities of food (freezer full)	QUICK FREEZING
◆ Make ice cubes	
◆ Fast-freeze food	
Store an average amount of food	NORMAL
Store a small amount of food (freezer relatively empty)	QUICK COOLING
Put the freezer compartment in winter mode when the ambient temperature drops below 10°C.	WINTER

- Depending on the room temperature, you may need to turn the freezer up or down slightly.

## Freezing Food

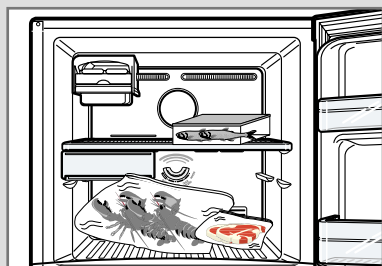
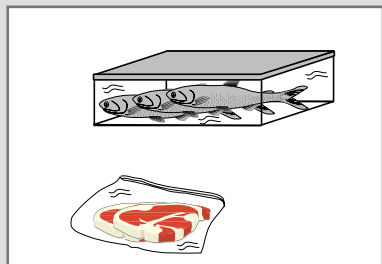

Follow the recommendations below when storing food in the freezer.

- 1 Store food in small quantities or as individual servings, so that you can defrost as much or as little as you like.
- 2 Do not refreeze food that has already been frozen and then defrosted.
- 3 Put the food to be frozen in containers with lids or in airtight plastic freezer bags, removing any excess air in the bags.
- 4 Respect the maximum storage times indicated on pre-packed frozen food.
- 5 Do not place food on top of the evaporation slots.
- 6 Try and maintain easy access to the temperature dial in case you need to adjust the temperature.
- 7 Leave the door open for as little time as possible. Make sure that it is properly closed after use.

## Making Ice Cubes (OPTION)

### *TWIST ICE MAKER*

#### *Making Ice Cubes*

- 1 Remove the ice cube tray by pulling it towards you.
- 2 Fill the tray with water up to the maximum water level marked on the rear of the tray.
- 3 Slide the tray back into the holder, taking care not to spill the water.
- 4 Wait until the ice cubes are formed.  
Freezing time: It is recommended that you wait for about one hour with the temperature set to QUICK FREEZING for the ice cubes to form.

#### *Removing the Ice Cubes*

- 1 Make sure that the ice cube storage bin is in place under the ice cube tray. If not, slide it into place.
- 2 Twist one of the levers firmly in the clockwise direction until the tray twists slightly.  
Result: The ice cubes fall into the storage bin.
- 3 Repeat Step 2 for the other half of the tray, if necessary.
- 4 Remove the storage bin by:
  - ◆ Lifting it slightly
  - ◆ Pulling it towards you

### *MOVABLE ICE TRAY*

#### *Making ice cubes*

- 1 Remove the ice cube tray by pulling it towards you.
- 2 Fill the tray with water up to the maximum water level marked on the rear of the tray.
- 3 Place it under the freezer shelf or on the freezer shelf .

#### *Removing the ice cubes*

To remove ice cubes, hold the tray at its ends and twist gently.

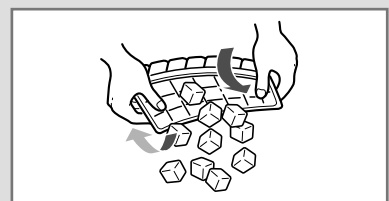
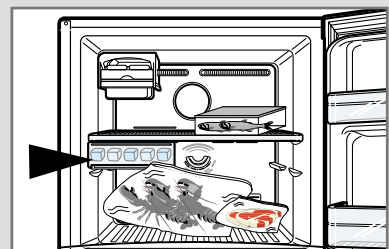
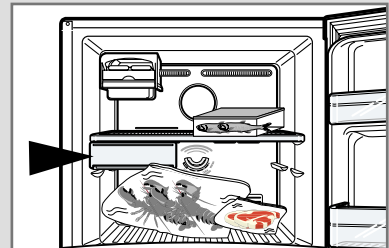
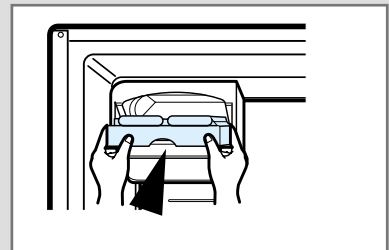
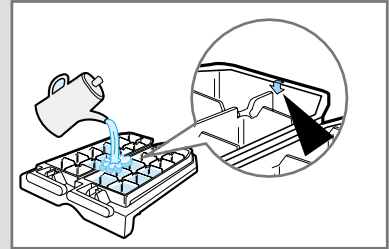
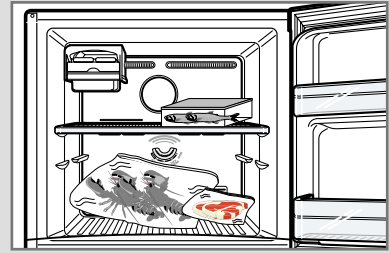

## Cleaning the Fridge/Freezer

EN

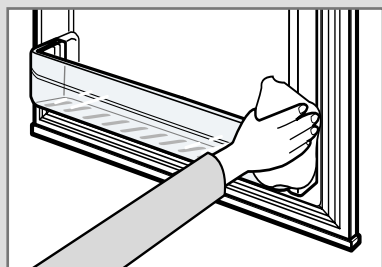
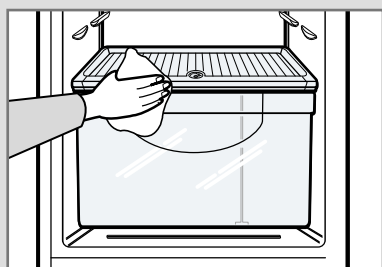
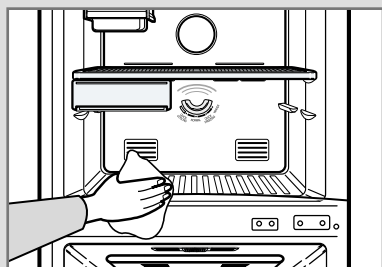
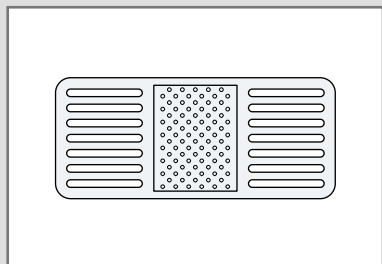
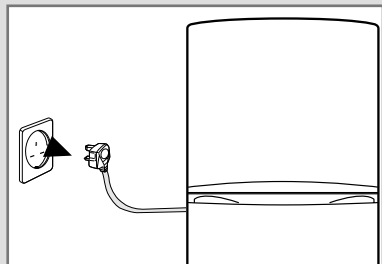

The following parts of your fridge/freezer should be cleaned regularly to prevent food particles from building up:

- ◆ Inside and outside surfaces
- ◆ Doors and door seals
- ◆ Accessories (shelves, compartments and ice tray)



ALWAYS ensure that:

- ◆ The door seals are clean
- ◆ The doors close properly

---

1 Whenever possible, unplug the fridge/freezer before cleaning it. If this is not possible, wring any excess moisture out of your sponge or cloth before cleaning around the:

- ◆ Lights
- ◆ Temperature dials

---

2 Clean the outside surfaces with a soft cloth and warm, soapy water. Rinse and dry.

---

3 Remove the accessories, referring to page 7 for further details, if necessary. Wash them with a soft cloth or sponge and warm, soapy water. Rinse and dry them.

---

4 If the refrigerator has an unpleasant smell:

- ◆ Remove the bio-deodorizer
- ◆ Soak the catalyst in pure water
- ◆ Dry it naturally in sunlight
- ◆ Put it back into position

---

5 Wipe the evaporation slots in the freezer with a clean, dry, soft cloth.



DO NOT allow any food particles to clog up these openings or frozen food to cover them.

---

6 Wipe the inside of the fridge/freezer with a soft cloth and warm, soapy water. Rinse and dry.

---

7 Carefully clean the door seals with a soft cloth and warm, soapy water. Rinse and dry.



DO NOT damage the seals in any way and make sure that no food particles on the seals prevent the door from closing properly as:

- ◆ The temperature will not be maintained correctly
  - ◆ Electricity will be wasted
-

## Changing the Light Bulb

**Caution : Unplug the refrigerator before replacing light Bulbs.**

When you open the refrigerator door, a light comes on to help you find what you are looking for more easily. If you need to replace the bulb, proceed as follows.

- 1 Remove the chiller compartment by:
  - ◆ Pulling it towards you until it meets the stop
  - ◆ Tilting the front up slightly and continuing to pull the compartment towards you
- 2 With a flat-bladed screwdriver, prise out the upper part of the light cover. Pull the cover free.
- 3 Unscrew and remove the light bulb.
- 4 Insert new bulb (maximum of 15 W, E14 small screw base).
- 5 Replace the light cover by pushing it until it clicks back into place.
- 6 Replace the chiller compartment by sliding it back into position.

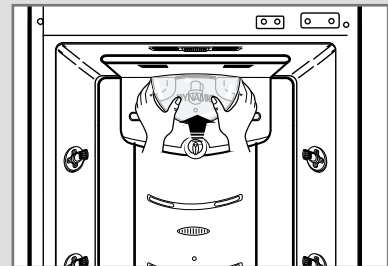
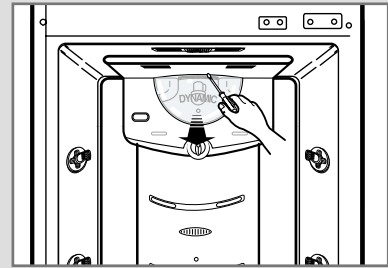

## Problems and Solutions

EN

*Before contacting the after-sales service, perform the following simple checks. They may save you the time and expense of an unnecessary call.*

Problem	Explanation/Solution
The fridge/freezer is not operating at all and the light does not come on when you open the refrigerator door	<ul style="list-style-type: none"> <li>◆ Check that the fridge/freezer is correctly plugged in.</li> <li>◆ Check that the wall outlet is switched on and working correctly.</li> </ul>
Food in the freezer does not freeze correctly	<ul style="list-style-type: none"> <li>◆ Is the temperature set correctly? If ice cream in the freezer is too soft, turn the temperature dial towards QUICK FREEZING; if it is too hard, turn the dial towards QUICK COOLING.</li> <li>◆ Is the room temperature too high? Is the appliance exposed to direct sunlight or a source of heat? Change its position if possible.</li> </ul>
Food freezes in the refrigerator	<ul style="list-style-type: none"> <li>◆ Is the temperature set to COLDER? Turn the temperature dial towards COLD.</li> <li>◆ Is the room temperature too low? If it is very low, the thermostatic controls may function incorrectly. Turn the freezer temperature dial towards "WINTER".</li> </ul>
The fridge/freezer makes unusual noises	<ul style="list-style-type: none"> <li>◆ Check that the fridge/freezer is installed on a level, stable surface with sufficient space around it; adjust the front feet if necessary (see page 6 for further details).</li> <li>◆ Are there any objects behind or under the fridge/freezer?</li> <li>◆ Is the noise coming from the compressor or does it sound like running water (refrigerant circulating)? These noises are normal.</li> </ul>
There is a bad smell in the refrigerator or freezer	<ul style="list-style-type: none"> <li>◆ Is an item of food going bad?</li> <li>◆ Is all food stored in sealed containers or covered?</li> <li>◆ Has dew developed in the vegetable bin? Clean and dry the bin.</li> <li>◆ Are the evaporation slots at the front of the freezer clogged? Clean and dry them carefully.</li> <li>◆ Clean the bio-deodorizer (refer to page 12).</li> </ul>
Dew develops in the refrigerator	<ul style="list-style-type: none"> <li>◆ Have you left the door open for a long time?</li> <li>◆ Is something preventing the door from closing properly? Carefully clean and dry the door seals.</li> <li>◆ Have you stored food or liquids in a container without a cover? Leave all food and liquids to cool before placing them in the refrigerator and keep them covered.</li> </ul>
Frost develops in the freezer	<ul style="list-style-type: none"> <li>◆ Have you left the door open for a long time?</li> <li>◆ Is something preventing the door from closing properly? Carefully clean and dry the door seals.</li> <li>◆ Are the evaporation slots at the front of the freezer clogged? Clean and dry them carefully.</li> <li>◆ Have you left enough room for the air to circulate? Space the food out as evenly as possible.</li> </ul>
The rear or sides of the fridge/freezer are warm	<ul style="list-style-type: none"> <li>◆ Is the room temperature too high or is the fridge/freezer exposed to a direct source of heat, causing the fridge/freezer to operate intensively? Move the fridge/freezer to a better position if possible.</li> <li>◆ Is there an excessively high humidity level in the room? Move the fridge/freezer to a better position if possible.</li> </ul>

*If you cannot solve the problem, note:*

- ◆ *The nature of the problem and any warranty information*
- ◆ *The type and model indicated on the centre of the fridge/freezer*

*Then contact your local dealer or nearest Samsung after-sales service.*

# View of Your Fridge/Freezer

